

VDI PERFORMANCE COMPARISON: DELL POWEREDGE FX2 AND FC430 SERVERS WITH VMWARE VIRTUAL SAN

DELL™ POWEREDGE™ FX2 SERVER SOLUTION

POWERED BY INTEL® XEON® PROCESSORS E5-2650 v3

A cost-effective shared storage compute solution



72%
more
users

91%
less
space

versus a legacy Cisco UCS® B200 M2 blade solution using a traditional SAN



The rapid adoption of virtual desktop infrastructure (VDI) across enterprises is forcing IT admins to rethink the way they equip their datacenters. Server performance, efficient use of space, cost-effectiveness, and ease of management all come into play as companies seek to maximize their investment. The legacy servers and complex storage solutions that once adequately supported VDI are no longer the best approach. Upgrading from an older solution to a new Intel Xeon processor E5-2650 v3-powered Dell PowerEdge FX2 solution using VMware Virtual SAN can allow you to support more users, reclaim valuable rack space, and gain enormous flexibility in your storage.

In the Principled Technologies (PT) labs, we tested two VDI solutions to find the number of virtual sessions each solution could support: (1) a Dell PowerEdge FX2 with Dell PowerEdge FC430 server sleds and FD332 storage using VMware Virtual SAN and (2) a five-year-old legacy Cisco UCS B200 M2 blade solution (first released 2010) using a traditional SAN. We found that the Dell solution using FC430 servers and FD332 storage nodes supported 400 virtual desktop users, while the five-year-old legacy Cisco UCS B200 M2 solution supported only 232 virtual desktop users. That's an increase of 72 percent, achieved in 91 percent less space and with a software-defined shared storage solution that is much easier to set up, manage, and use than traditional storage arrays.



Upgrading from an older virtual desktop infrastructure to the Dell PowerEdge FX2 with VSAN and the latest-generation Intel Xeon processors can deliver a dramatic performance boost, support more users, save space, while costing only \$176.52 per user based on hardware costs.

OVERVIEW – THE DELL POWEREDGE FX2 ENCLOSURE

The shared infrastructure approach of the Dell PowerEdge FX2 enclosure is scalable and can help you make the most of your data center space while reducing rack space. The Dell PowerEdge FX2 enclosure has a standard 2U footprint and features a modular design that can hold different combinations of compute and storage nodes to meet your specific goals. The PowerEdge FX2 fits four half-width or eight quarter-width compute nodes to increase the compute density in your rack and optimize the space in your data center. You can deploy the FX2 solution like a traditional rack-mounted server while gaining the benefits and features that more expensive dense blade solutions provide. Important features of the FX2 enclosure include:

- Up to eight low-profile PCIe expansion slots
- Two pass-through or optional networking FN I/O Aggregator modules
- Embedded network adapters within the server nodes
- Offers both chassis-based management through the Chassis Management Controller and rack-based management through Integrated Dell Remote Access (iDRAC) with Lifecycle Controller on each compute node

The Dell PowerEdge FX2 enclosure fits a number of server and storage options, including the PowerEdge FM120, FC430, FC630, and FC830 servers, and PowerEdge FD332 storage node – all Intel-powered. For more information about the Intel-powered Dell PowerEdge FX2 solution, visit www.dell.com/us/business/p/poweredge-fx/pd.

THE ADVANTAGES OF THE DELL SOLUTION WITH VMWARE VIRTUAL SAN

Extreme space efficiency

The Dell PowerEdge FX2 solution we tested included four quarter-width Dell PowerEdge FC430 server sleds powered by dual Intel Xeon processors E5-2650 v3 and two half-width Dell FD332 storage units, each of which contained a mix of SSDs and HDDs (see Figure 1).

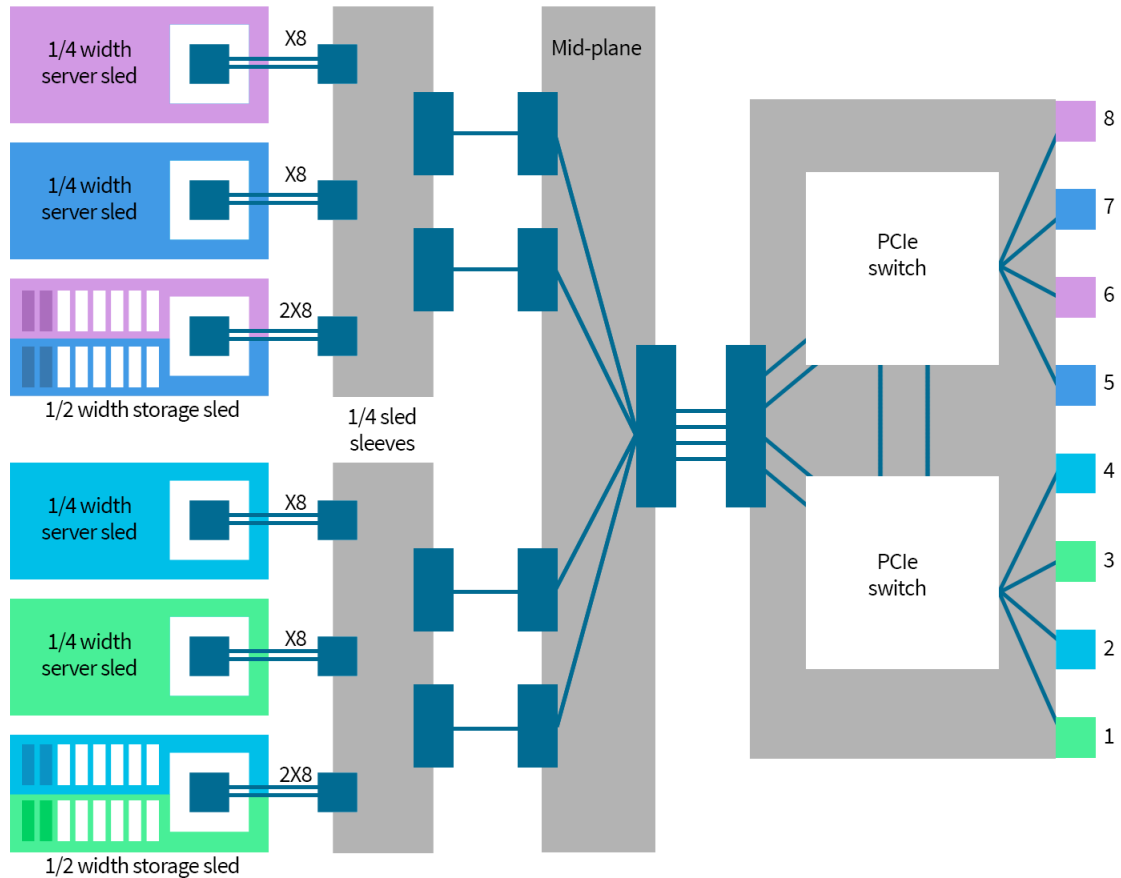

Figure 1: The components of the Dell PowerEdge FX2 solution we tested.

Each of the server sleds have access to eight drives on a corresponding storage unit, and the entire solution, which ran both the VDI workload and VMware Virtual SAN on all four servers for the 400 supported user tests, fits within a single 2U enclosure.

Figure 2 illustrates the extreme space-efficiency of the Dell PowerEdge FX2 solution we tested, which required one-tenth the space required by the legacy Cisco solution. This means you can save significant data center space as you upgrade your VDI infrastructure to meet current needs. Additionally, this has enormous cost-savings potential for your organization in having less hardware to manage, maintain, and having the ability to scale out your VDI infrastructure without having to expand your data

center. We used a mixed of 2.5" and 3.5" disks on the Cisco legacy solution so that both solutions had at least 20TB of raw capacity. The industry-leading SAN solution is close to 23TB raw capacity while the FX2 solution has approximately 30TB of raw capacity.

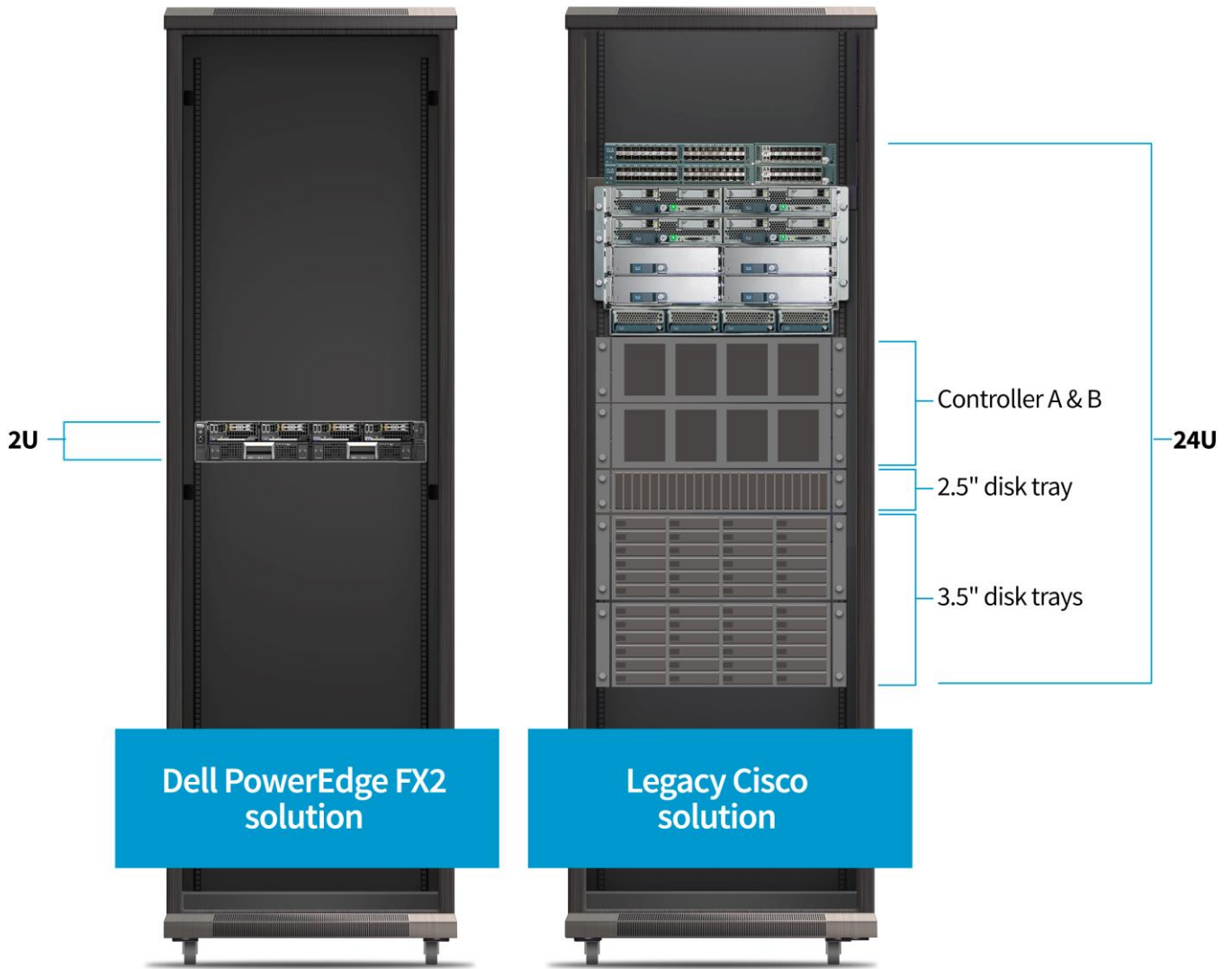

Figure 2: The space requirements of the Dell PowerEdge FX2 solution vs. the legacy Cisco solution.

Simplified network integration

As part of the PowerEdge FX architecture, Dell Networking FN IO Aggregators are designed to simplify FX2 connectivity with Internet Group Management Protocol (IGMP) snooping capabilities and support for multicast traffic, lowering latency and improving VSAN cluster performance. The FN IO Aggregators can manage east-west traffic flows within the IO module for up to four VSAN nodes. This capability allows network administrators to reduce the number of top-of-rack (ToR) switches, 10GbE ports, and cables needed to run server clusters while reducing overall networking cost. For example, a Principled Technologies study found that adding redundant FN IO Aggregators to a Dell PowerEdge FX2 configuration with four Dell PowerEdge FC630 servers saved \$24,416 or 28.5 percent on networking costs when compared to HP ProLiant DL360 Gen9 rack servers.

For more details about this networking cost savings study, visit www.principledtechnologies.com/Dell/PowerEdge_FX2_networking_costs_0115.pdf

Easier to configure and manage storage with VMware VSAN

Our solution also used VMware Virtual SAN, a software-defined shared storage solution that allows policy-based provisioning of direct-attached storage on server nodes. It automates many manual storage tasks and offers flexibility that lets companies grow their storage environments as they need to. It uses a flash pool as a read/write storage cache, improving the performance of direct-attached disks. This software-defined shared storage solution automates many manual storage tasks such as disk management, storage optimization, and failure tolerance and offers flexibility that lets companies increase storage capacity by adding more HDDs to new or existing hosts on the fly.

With VSAN, you can maximize VDI density using the existing direct-attached storage without having to invest in external storage solutions. Virtual SAN's simple, easy-to-use design has the potential to increase operational efficiency, saving you both time and money. For more information about VMware Virtual SAN, visit www.vmware.com/products/virtual-san

Superior performance

We compared the VDI performance of the Dell PowerEdge FX2 with Dell PowerEdge FC430 server sleds and VSAN to that of a legacy environment with the five-year-old Cisco UCS B200 M2 blades and a traditional SAN approach to storage. (For more details on the configuration of the two solutions, see [Appendix A.](#))

Enterprises looking to upgrade to the latest generation hardware will benefit from moving their VDI workloads from older hardware to the Intel Xeon processor-powered Dell PowerEdge FX2. The comparison in this paper demonstrates the

performance benefits of upgrading to the Dell PowerEdge FX2 solution while simplifying storage configuration and saving valuable datacenter floor space. To perform this comparison, we configured the servers—the Dell PowerEdge FX2 using VMware Virtual SAN and the legacy Cisco server using a traditional SAN—with VMware vSphere 5.5, and then we set up a VMware Horizon 6 (with View) virtual desktop pool. Next, we executed VDI testing using the knowledge-worker workload from the Login VSI 4.1 benchmark to determine the VSI_{max}, or total number of users performing a heavy, graphics-intensive workload each solution could support before reaching a failing point. (For the specifics of our testing, see [Appendix B.](#))

More sessions supported

We found that the Dell PowerEdge FX2 running a VDI workload on one FC430 servers and using VMware Virtual SAN on all four FC430 servers could host 100 concurrent sessions while retaining a satisfactory user experience. This is 72 percent more than a single legacy Cisco server using a traditional SAN, which could host only 58 sessions before experiencing slow end-user response time due to CPU saturation (see Figure 3).

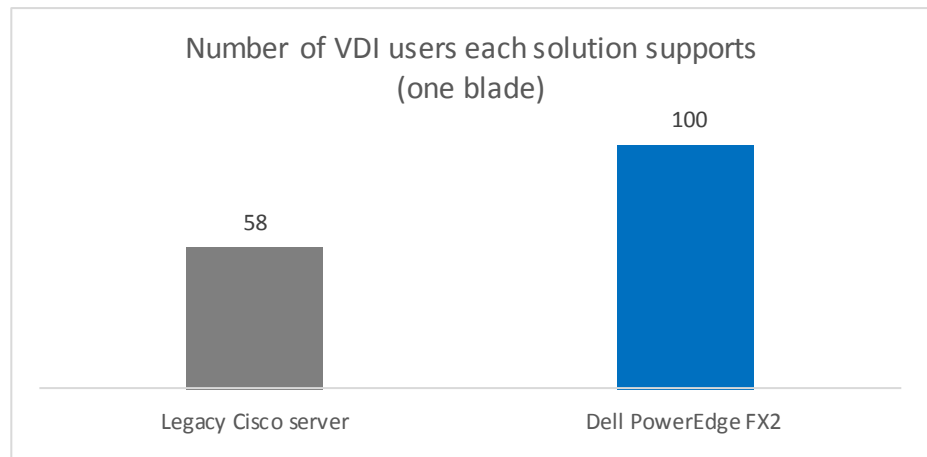
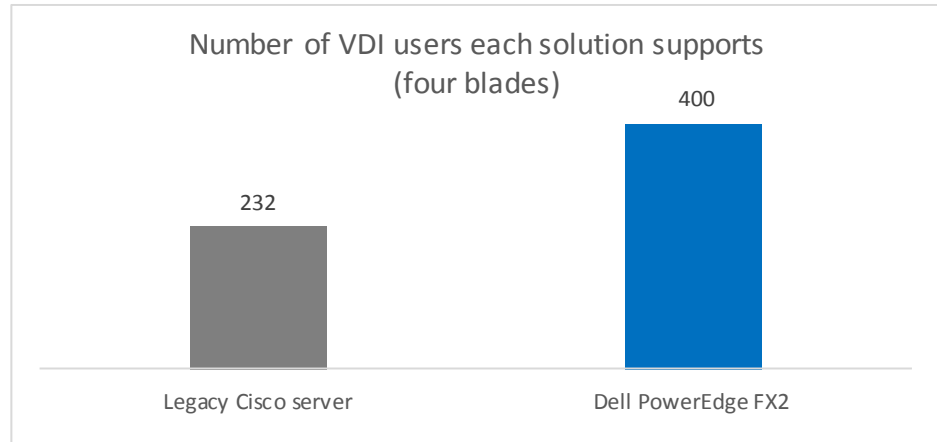

Figure 3: The Dell PowerEdge FX2 running the VDI workload on one FC430 server supported 72 percent more VDI users than a single legacy Cisco server.

We then increased the number of FC430 server sleds running the VDI workload in the Dell PowerEdge FX2 and the number of blades on the legacy Cisco solution running the same workload to four, and found that performance scaled evenly, supporting 400 and 232 sessions respectively (see Figure 4).

Figure 4: With four FC430 sleds, the FX2 supported four times as many users as with one blade, as did the legacy server.



Faster Login VSI response times

Figures 5 and 6 show the Login VSI response times, in milliseconds, for the two solutions with one sled or blade each. The Dell PowerEdge FX2 solution using VMware Virtual SAN was able to run 100 sessions, which was limited by the maximum number of virtual machines supported by one VSAN 5.5 host, without reaching VSI_{max}. VSI_{max} represents the maximum user capacity at which performance will degrade; therefore, not reaching VSI_{max} is a positive indicator that response time remained satisfactory. Due to CPU constraints, the legacy Cisco server using traditional SAN was able to run only 58 sessions without reaching VSI_{max}. Adding additional sessions caused the server blade to reach VSI_{max} due to CPU saturation, which degraded end-user response times to unacceptable levels. An explanation of the metrics Login VSI reports appears in [Appendix B](#).

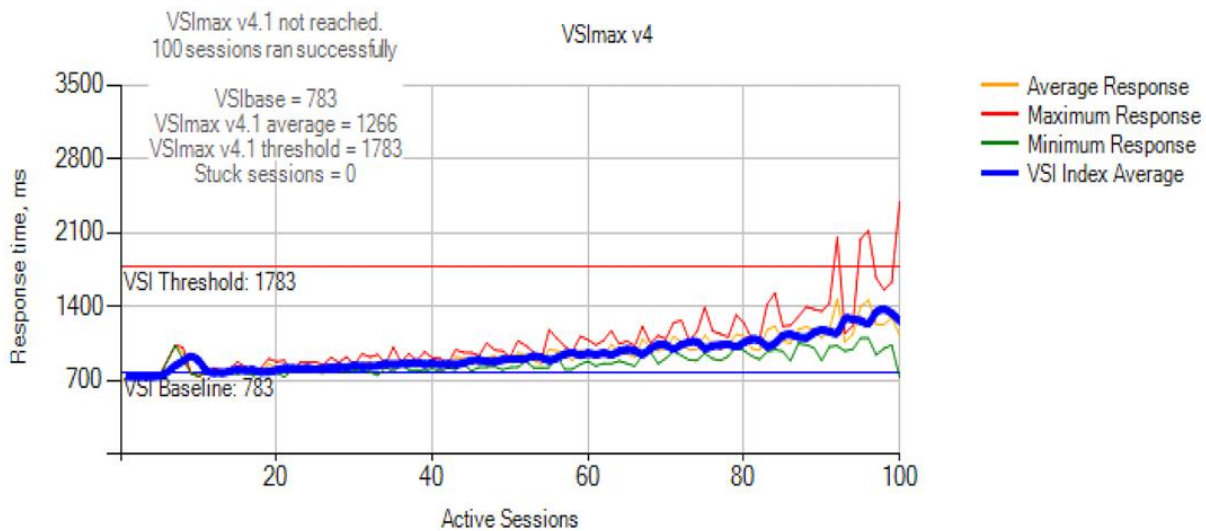

Figure 5: The Dell PowerEdge FX2 using VMware Virtual SAN with a single FC430 sled ran 100 sessions, with room to grow. VMware Virtual SAN 5.5 limits allowed only 100 sessions per server.

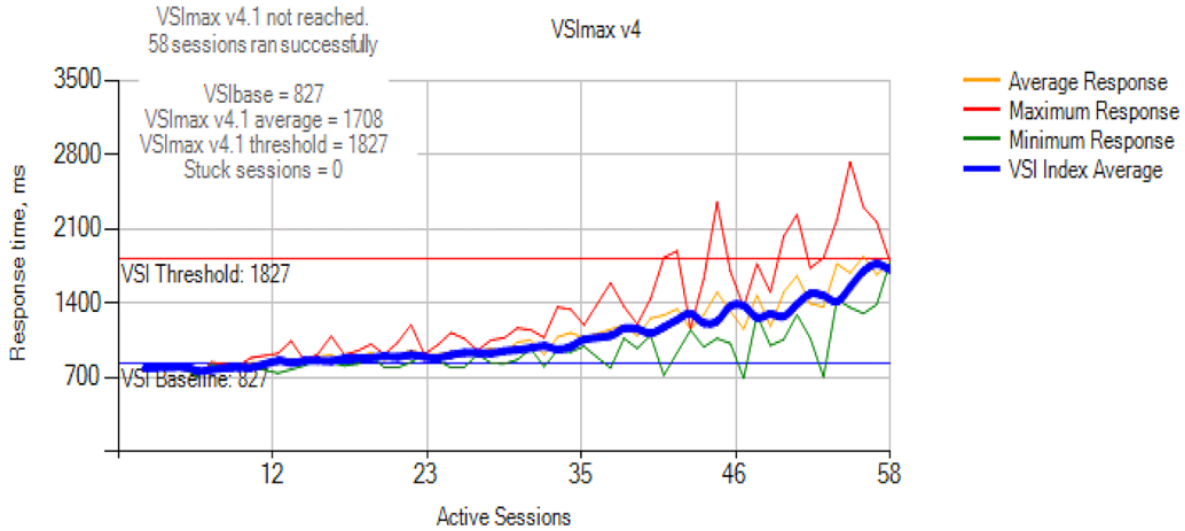

Figure 6: The legacy Cisco server using a traditional SAN with a single B200 M2 blade ran 58 sessions and did not reach VSImax; Adding additional sessions caused the server to reach VSImax due to CPU saturation and unacceptable end-user response times.

Figures 7 and 8 show the Login VSI response times, in milliseconds, for the two solutions with four sleds or blades each. The Dell PowerEdge FX2 solution using VMware Virtual SAN was able to run 400 sessions (the maximum number of virtual machines supported by four VSAN 5.5 hosts) without reaching VSImax. As we note above, VSImax represents the maximum user capacity at which performance will degrade; therefore, not reaching VSImax is a positive indicator that response time remained satisfactory. Due to CPU constraints, the legacy Cisco server using traditional SAN was able to run only 232 sessions without reaching VSImax. Adding additional sessions caused the server to reach VSImax due to CPU saturation, which degraded end-user response times to unacceptable levels.

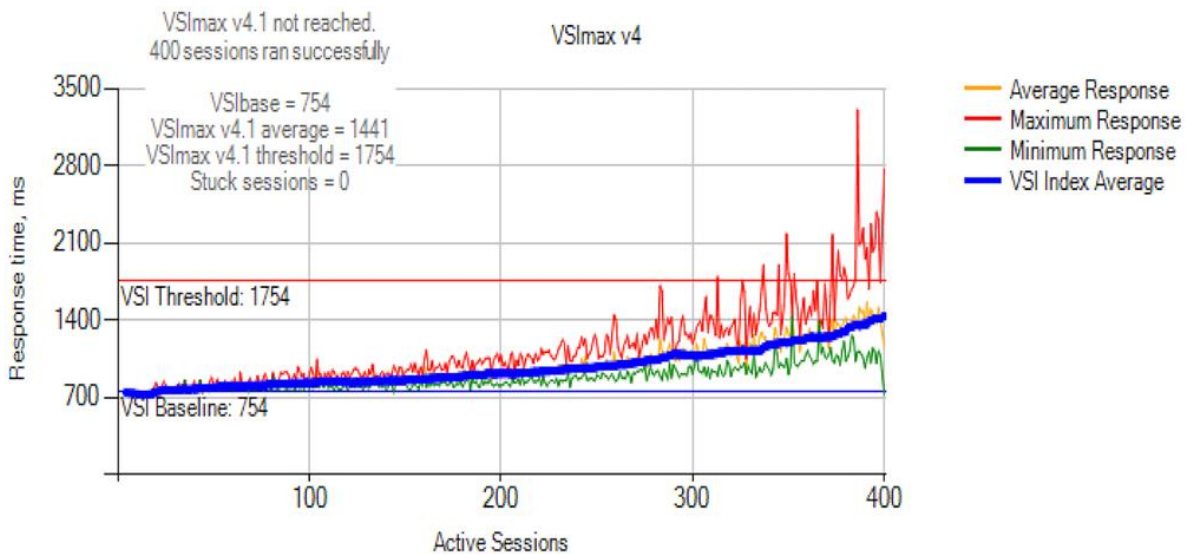

Figure 7: The Dell PowerEdge FX2 using VMware Virtual SAN with four FC430 sleds ran 400 sessions (100 per server), with room to grow. VMware Virtual SAN 5.5 limits allowed only 100 sessions per server.

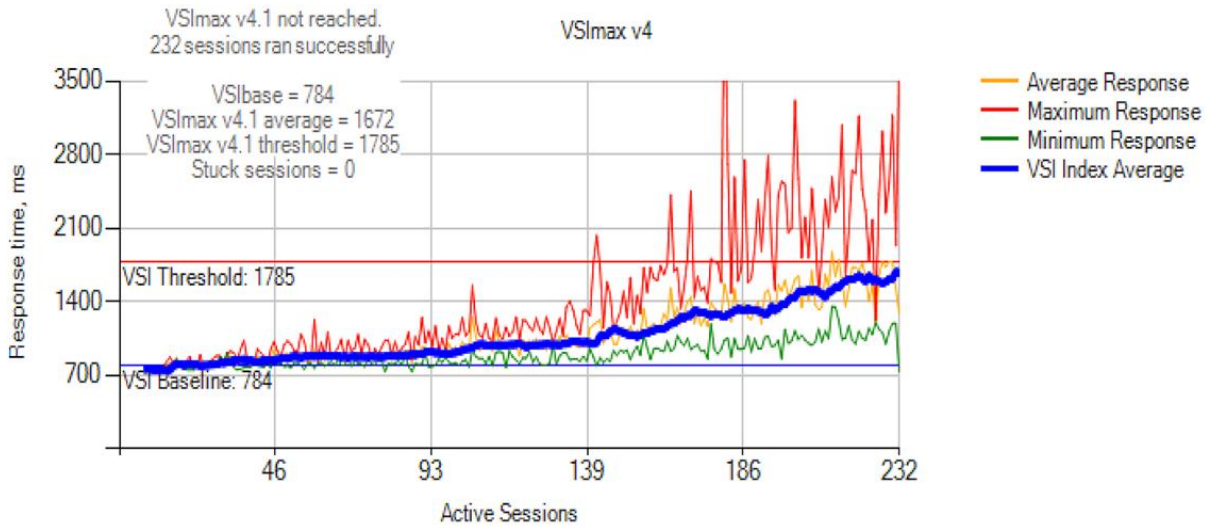

Figure 8: The legacy Cisco server using a traditional SAN with four B200 M2 blades ran 232 sessions and did not reach VSImax; Adding additional sessions caused the server to reach VSImax due to CPU saturation and unacceptable end-user response times.

Lower CPU utilization

Figures 9 and 10 show vSphere 5.5 server counters for CPU utilization throughout the test for the two solutions with one sled or blade each. CPU utilization increases as more users log in. In our tests, processing power further limited the number of users the Cisco UCS B200 M2 blade was able to support compared to the Dell PowerEdge FX2 solution.

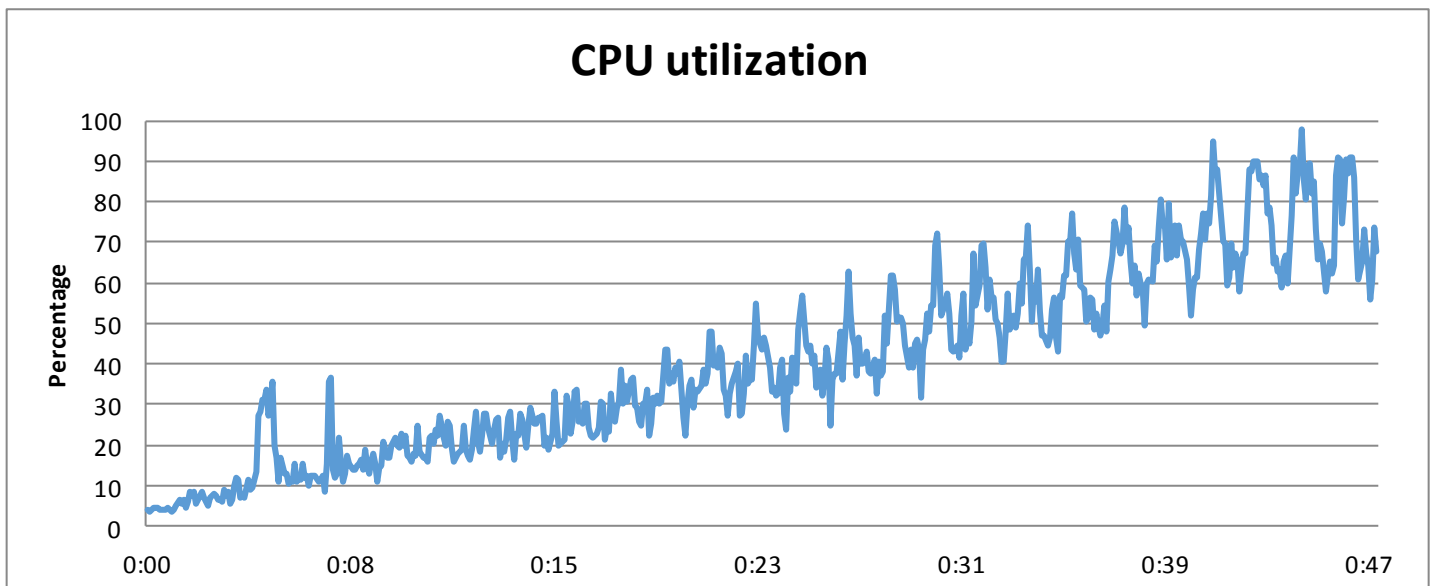

Figure 9: CPU utilization throughout our test period for the Dell PowerEdge FX2 using VMware Virtual SAN with one FC430 sled.

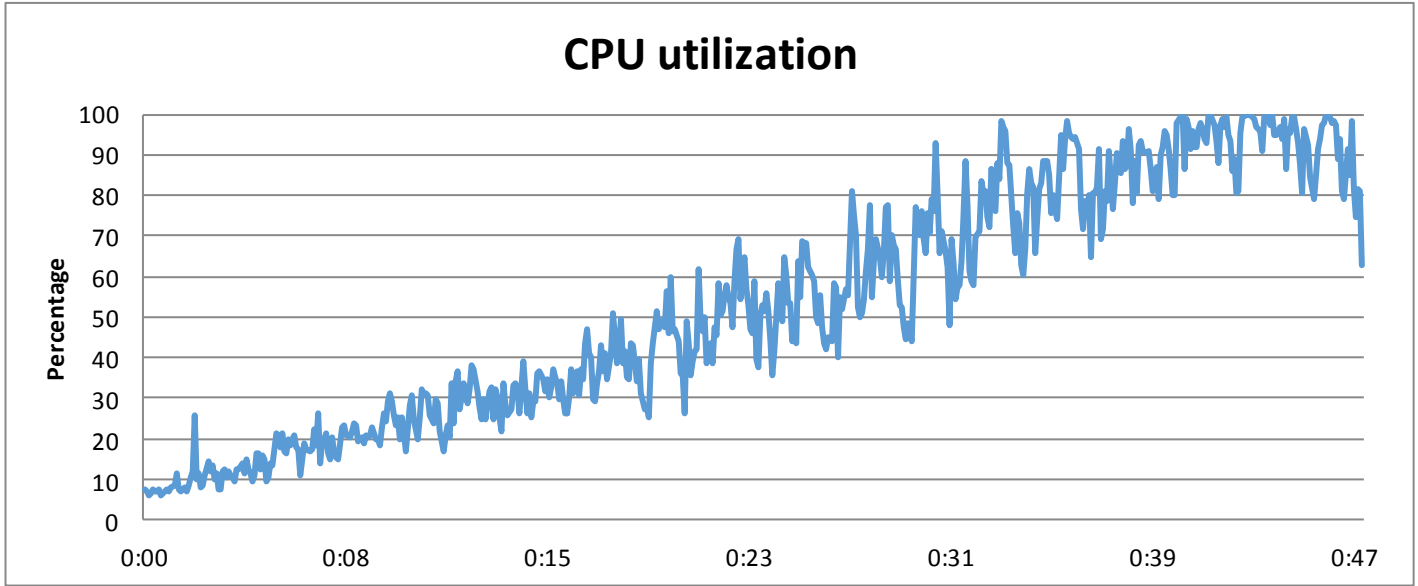

Figure 10: CPU utilization throughout our test period for the legacy Cisco server using a traditional SAN with one B200 M2 blade.

Figures 11 and 12 show vSphere 5.5 server counters for CPU utilization throughout the test for the two solutions with four sleds or blades each. CPU utilization increases as more users log in. CPU limited the number of users the Cisco UCS B200 M2 blades were able to support to 232 sessions, significantly lower than the 400 sessions supported by the Dell PowerEdge FX2 solution.

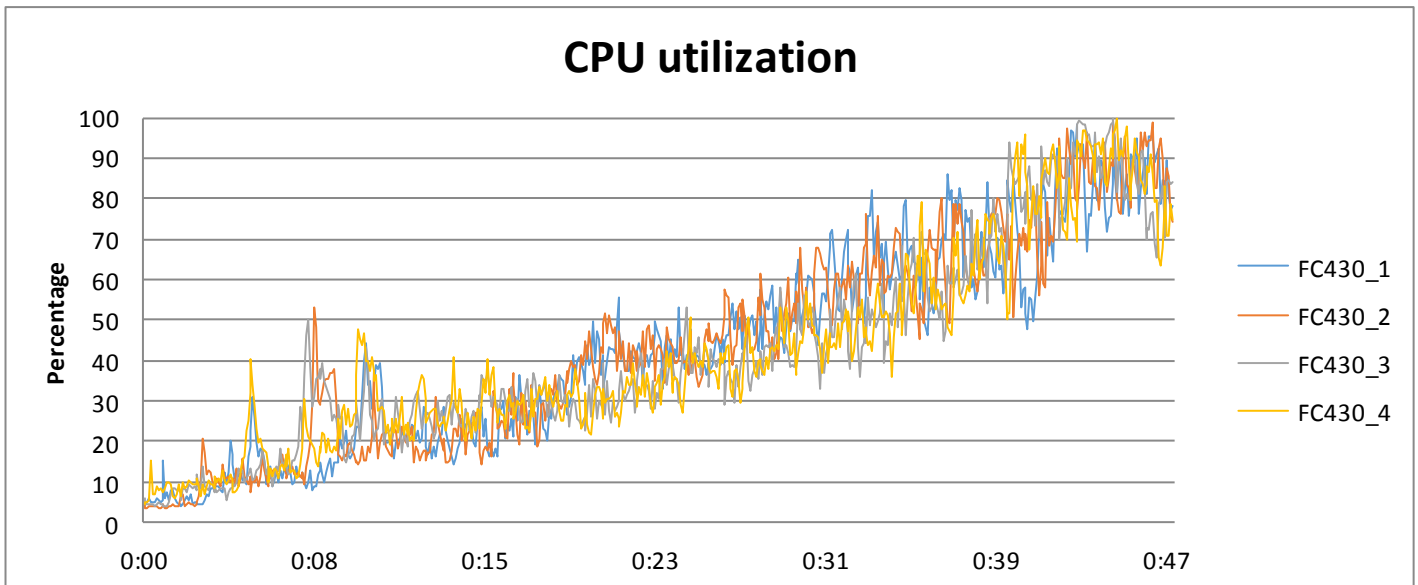

Figure 11: CPU utilization throughout our test period for the Dell PowerEdge FX2 using VMware Virtual SAN with four FC430 sleds.

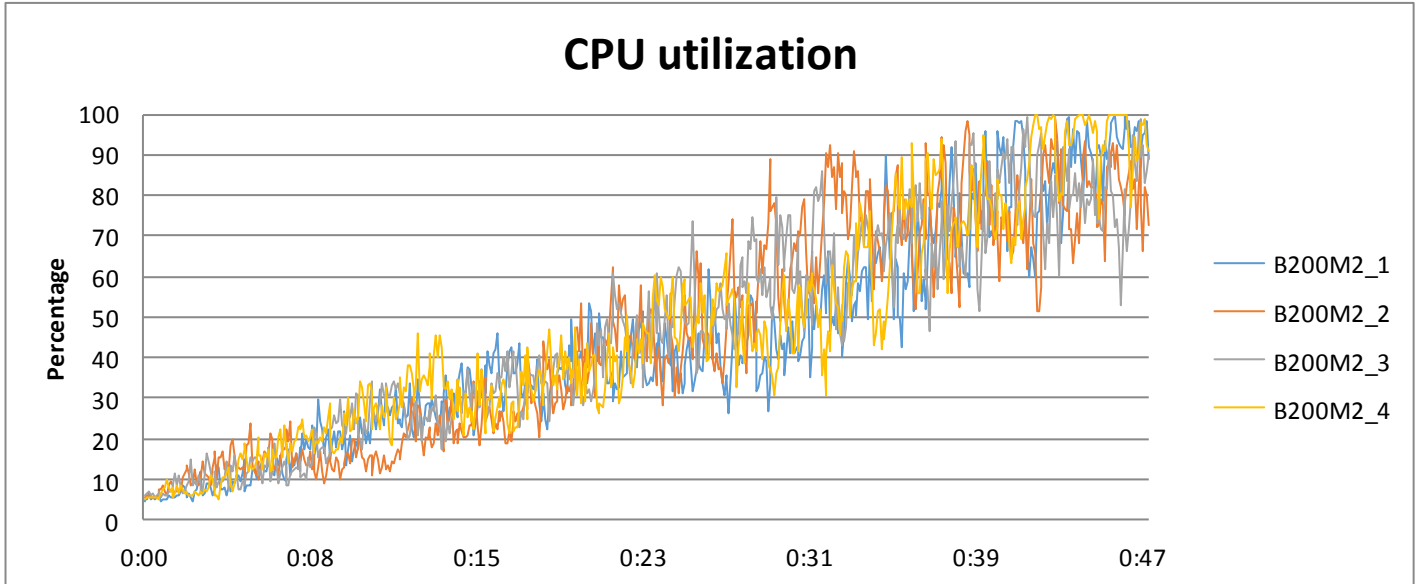

Figure 12: CPU utilization throughout our test period for the legacy Cisco server using a traditional SAN with four B200 M2 blades.

Great affordability

The space savings and added performance of the latest generation Intel Xeon processor-powered Dell PowerEdge FX2 solution with FC430 servers and VMware Virtual SAN already offers potential savings from having to maintain and manage less hardware for a greater number of VDI users when compared to the legacy Cisco solution and traditional SAN. In addition to this, the Dell PowerEdge FX2 solution cost provides an efficient solution that comes in at a low cost per VDI user. The Dell solution we tested delivered up to 400 VDI user session and cost \$70,609.00.¹ That’s only \$176.52 per user. Figure 13 shows the hardware cost of the Dell PowerEdge FX2 solution.

Solution Component	Quantity	Total cost
PowerEdge FX2 chassis for two half-width and up to four quarter-width nodes	1	\$4,585.00
PowerEdge FC430 server node with Intel Xeon processors E5-2650 v3 and 128 GB of memory	4	\$36,856.00
PowerEdge FD332 storage node with dual controllers and (4) 200GB SSD and (12) 1.2TB 10k HDD	2	\$29,168.00
Total cost		\$70,609.00

Figure 13: Detailed hardware pricing.

¹ Pricing is for hardware only and does not include any software or licenses. Pricing provided by Dell.

IN CONCLUSION

Replacing your legacy VDI servers with a new Intel Xeon processor E5-2650 v3-powered Dell PowerEdge FX2 solution using VMware Virtual SAN can be a great boon for your enterprise.

In the Principled Technologies (PT) labs, this space-efficient, affordable solution outperformed a five-year-old legacy server and traditional SAN by offering 72 percent greater VDI users. Additionally, it achieved greater performance while using 91 percent less space and at a cost of only \$176.52 per user in hardware costs.

By supporting more users, saving space, and its affordability, an upgrade to the Intel-powered Dell PowerEdge FX2 solution using VMware Virtual SAN can be a wise move when replacing your aging, older infrastructure.

APPENDIX A – SYSTEM CONFIGURATION INFORMATION

Figure 14 provides detailed configuration information for the test systems.

System	Dell PowerEdge FX2 FC430 Sled	Cisco UCS B200 M2 Blade Server
Enclosure		
Blade enclosure	PowerEdge FX2	Cisco UCS 5108
Power Supplies		
Total number	2	4
Wattage of each (W)	1,600	2,500
Cooling fans		
Total number	8	8
General		
Number of processor packages	2	2
Number of cores per processor	10	6
Number of hardware threads per core	2	2
System power management policy	High Performance	High Performance
CPU		
Vendor	Intel	Intel
Name	Xeon	Xeon
Model number	E5-2650 v3	X5760
Stepping	7	C0
Socket type	LGA2011	LGA1366
Core frequency (GHz)	2.30	2.93
Bus frequency	9.6 GT/s	8.0. GT/s
L1 cache	320 KB	192 KB
L2 cache	2.50 MB	1.5 MB
L3 cache	25 MB	12 MB
Platform		
Vendor and model number	PowerEdge FC430	Cisco UCS B200 M2
Motherboard model number	0H05YT	N20-B6625-1
BIOS name and version	0.3.10	Cisco S5500.2.1.3.0.081620131102
BIOS settings	Default	Default
Memory module(s)		
Total RAM in system (GB)	128	96
Vendor and model number	Samsung M393A2G40DB0-CPB	Micron MT36KSZF1G72PZ-1G4D1AD
Type	DDR4-2133 PC4-17000	DDR3-1333 PC3-10600
Speed (MHz)	2,133	1,333
Speed running in the system (MHz)	2,133	1,333
Size (GB)	16	8
Number of RAM module(s)	8	12
Chip organization	Double-sided	Double-sided

System	Dell PowerEdge FX2 FC430 Sled	Cisco UCS B200 M2 Blade Server
Operating system		
Name	VMware vSphere 5.5.0	VMware vSphere 5.5.0
Build number	2143827	2143827
Language	English	English
RAID controller		
Vendor and model number	Dell PERC FD33xD	LSI logic SAS 1064E
Firmware version	25.2.1.0037	01.32.09.00
Hard drives		
Vendor and model number	HGST HUC101212CSS600	Seagate ST9146803SS
Number of drives	6	2
Size (GB)	1,200	146
RPM	10,000	10,000
Type	SAS	SAS
Hard drives		
Vendor and model number	Toshiba PX02SMF020	n/a
Number of drives	2	n/a
Size (GB)	200	n/a
Type	SSD	n/a
Network adapter		
Vendor and model number	Broadcom NetXtreme II 10 GbE BCM57810	Cisco UCS M81KR
Vendor and model number	Dell FN410S IO Aggregator	n/a

Figure 14: System configuration information for the test systems.

APPENDIX B – OUR TEST APPROACH

About our test tool, Login VSI 4.1

Login Virtual Session Indexer (Login VSI) is a tool that helps assess the virtual desktop performance, capacity, and scalability of a server. The newest version, Login VSI 4.1, has a number of improvements over previous versions. These include the following:

- More realistic user workload patterns
- All workloads are now a 48-minute loop instead of 14 minutes
- Alternating initial segment for each session to ensure equal load distribution
- HTML5 video player instead of flash (flash player is still optional)
- More realistic data set and data/file access in Login VSI workload
- More and larger websites
- MP4 video library with all formats: 480p, 720p and 1080p

Login VSI 4.1 reports the following metrics:

- Minimum Response: The minimum application response time
- Average Response: The average application response time
- Maximum Response: The maximum application response time
- VSI Baseline: Average application response time of the first 15 sessions
- VSI Index Average: The VSI index average is the average response time dropping the highest and lowest 2 percent

For more information about Login VSI 4.1, see <http://www.loginvsi.com/product-overview>.

Equipment

Server name	# of servers	Model	Processors	Memory (GB)	Functional role
Infrastructure	4	Intel processor-based servers	2 X Intel Xeon E5-2650 v3	128	VDI infrastructure and Login VSI launchers
FX2+FC430 sleds	4	Dell PowerEdge FC430	2 x Intel Xeon E5-2650 v3	128	Dell SUT
UCS + Cisco Legacy server	4	Cisco B200 M2	2 x Intel Xeon X5670	96	Cisco SUT

Figure 15: Detailed server specifications.

We installed and configured the latest available version of VMware vSphere 5.5 U2 on the Dell FC430 sleds, Cisco B200 M2 blades and infrastructure servers. For the Dell solution, we created a VSAN cluster using four FC430 and enabled all local disks to automatically be claimed by the Virtual SAN. We used the default VSAN storage policy, which uses the following settings:

- Number of failures to tolerate = 1
- Number of disk stripes per object = 1

- Object space reservation = 0%
- Flash read cache reservation = 0%
- Force provisioning = NO

We configured the Cisco solution to use a SAN storage appliance from a leading provider in the industry.

Storage array	Dell Virtual SAN	Industry-leading SAN solution
Number of controllers	N/A	2
RAID level	Automatically managed by VSAN	Dual Parity
Number of 3.5" disk enclosures	0	2
Number of 2.5" disk enclosures	0	1
Number of drives, type 1	24	32
Drive size (GB)	1,200	600
Drive type	6Gb SAS	6Gb SAS
Number of drives, type 2	8	12
Drive size (GB)	200	200
Drive type	SSD	SSD

Figure 16: Detailed storage specifications.

We used two Dell Networking 8024F switches to provide connectivity between infrastructure servers, servers under test, and storage, and configured the Cisco and Dell solutions to use two 10Gb ports for networking per server. One port was used to carry private VDI traffic and manage the vSphere servers, and the second port was used to connect to the storage. While we did not set up the FN IO Aggregators for internal switching, note that they can be configured to move traffic internally between VSAN nodes, potentially reducing the number of switches, 10Gb ports, and cables needed, along with their associated costs, to run the server cluster as discussed on the simplified network integration section on page 4.

On the infrastructure servers, we installed and configured VMware View horizon 6.0 to use a VMware vCenter and VMware Composer Server. We created two automated, floating, linked clone pools, and configured the pools to use 1 GB of host cache. Linked clones were configured with two vCPUs and 1.5 GB of memory.

VM and storage configuration

PT will install and configure VMs as indicated in Figure 17.

VM name	Qty.	OS	Role	Host(s)	vCPUs	Mem (GB)	vDisk (GB)
DC1	1	Windows 2008 R2	Active Directory, DNS, DHCP	Infrastructure	2	4	100
VSI_Share	1	Windows 2008 R2	Login VSI share	Infrastructure	2	2	100
vCenter	1	Windows 2008 R2	VMware vCenter	Infrastructure	4	8	100
Composer	1	Windows 2008 R2	VMware Composer	Infrastructure	2	2	100
View	1	Windows 2008 R2	VMware View server	Infrastructure	2	4	100
SQL	1	Windows 2008 R2	vCenter, and Composer DB server	Infrastructure	2	4	100
L01-I24	24	Windows 7 (x64)	Login VSI Launcher	Infrastructure	2	8	40
View VMs	400	Windows 7 (x86)	VMware Virtual Desktops	DELL/Cisco SUT(s)	2	1.5	24

Figure 17: Detailed VM configuration.

We used the Login VSI 4.1 KnowledgeWorker workload to generate a reproducible, real-world test case against the virtual desktops pools that simulated the execution of various applications including Microsoft® Internet Explorer®, Microsoft Office applications and high definition videos. Using Login VSI, we could determine how many virtual desktop users each solution could support.

We configured Login VSI to run in benchmark mode to create a default test environment in which we could compare test results with each other. Login VSI measures the total response time of multiple operations from each session and at the beginning of each test, samples a small set of virtual desktops to generate a VSImax Baseline. As more sessions begin to consume system resources, response time degrades and the VSI response time increases until it reaches VSImax. VSImax is reached when the VSImax + a 1,000-ms latency threshold is reached by the average VSI response time result. When this condition is met, the benchmark records a Login VSImax, which is the maximum number of sessions that platform could support. Not reaching VSI max is an indication of good end user response time. For more information about VSImax see www.loginvsi.com/documentation/index.php?title=VSImax

Installing VMware ESXi 5.5 on the infrastructure servers and servers under test

1. Attach the installation media.
2. Boot the server.
3. At the VMware Installer screen, press Enter.
4. At the EULA screen, press F11 to Accept and Continue.
5. Under Storage Devices, select the appropriate virtual disk, and press Enter.
6. Select US as the keyboard layout, and press Enter.
7. Enter the root password twice, and press Enter.
8. Press F11 to start installation.
9. After the server reboots, press F2 and enter root credentials.
10. Select Configure Management Network, and press Enter.
11. Select the appropriate network adapter, and select OK.
12. Log into the server using the VMware vSphere client.
13. Select the Configuration tab, and click Networking.
14. Click Add Networking...
15. Create the management network.
16. Click on the Configuration tab, and select Time configuration to configure server time.
17. Click DNS and Routing, and confirm the settings.

Setting up a VM to host the Microsoft Windows Active Directory® server (DC1)

1. Connect to the infra1 server via the VMware vSphere client.
2. Log in as `root`
3. In the VMware vSphere client, under Basic Tasks, select Create a new virtual machine.
4. Choose Custom, and click Next.
5. Assign the name DC1 to the virtual machine, and click Next.
6. Select infra1 as the host, and click Next.
7. Select the appropriate storage, and click Next.

8. Choose Virtual Machine Version 9, and click Next.
9. Choose Windows, choose Microsoft Windows Server® 2008 R2 (64-bit), and click Next.
10. For CPUs, select one virtual processor socket, and two cores per virtual socket, and click Next.
11. Choose 4 GB RAM, and click Next.
12. Click 1 for the number of NICs, select VMXNET3, connect to the PRIV-NET network, and click Next.
13. Leave the default virtual storage controller, and click Next.
14. Choose to create a new virtual disk, and click Next.
15. Make the OS virtual disk size 100 GB, choose thin-provisioned lazy zeroed, specify external storage, and click Next.
16. Keep the default virtual device node (0:0), and click Next.
17. Click Finish.
18. Right-click the VM, and choose Edit Settings.
19. Click the Resources tab, and click Memory.
20. Select Reserve all guest memory, and click OK.
21. Connect the VM virtual CD-ROM to the Microsoft Windows Server 2008 R2 installation disk.
22. Start the VM.

Installing the Microsoft Windows Server 2008 R2 operating system on the VM

1. Open a virtual machine console on DC1.
2. Choose the language, time and currency, and keyboard input. Click Next.
3. Click Install Now.
4. Choose Windows Server 2008 R2 Enterprise (Full Installation), and click Next.
5. Accept the license terms, and click Next.
6. Click Custom.
7. Click the Disk, and click Drive options (advanced).
8. Click New→Apply→Format, and click Next.
9. After the installation completes, click OK to set the Administrator password.
10. Enter the administrator password twice, and click OK.
11. Install VMware Tools. For more information, see kb.vmware.com/selfservice/microsites/search.do?language=en_US&cmd=displayKC&externalId=340.
12. Reboot the server.
13. Connect the machine to the Internet, and install all available Windows updates. Restart as necessary.
14. Enable remote desktop access.
15. Change the hostname to DC1, and reboot when the installation prompts you.
16. Set up networking for the data network:
 - a. Click Start→Control Panel, right-click Network Connections, and choose Open.
 - b. Right-click the VM traffic NIC, and choose Properties.
 - c. Uncheck TCP/IP (v6).
 - d. Select TCP/IP (v4), and choose Properties.

- e. Set the IP address as 172.16.0.10/255.255.0.0

Installing Active Directory and DNS services on DC1

1. Click Start→Run, type `dcpromo`, and click OK.
2. At the Active Directory Domain Services Installation Wizard welcome screen, check the Use advanced mode installation option, and click Next.
3. In the Choose a Deployment Configuration dialog box, select Create a new domain in a new forest, and click Next.
4. At the FQDN page, type `domain.local`, and click Next.
5. At the NetBIOS name prompt, leave the name `domain`, and click Next.
6. At the Forest Functionality level, select Windows Server 2008 R2, and click Next.
7. At the additional Domain Controller Options, leave DNS server selected, and click Next.
8. Assign a Directory Services Restore Mode Administrator account password, and click Next.
9. At the Summary screen, review your selections, and click Next.
10. Once Active Directory Domain Services finishes installing, click Finish, and restart the system.
11. Click Start→Run, and type `dnsmgmt.msc`
12. Create a reverse lookup zone for DC1.
13. Create static entries for the three infrastructure servers and the five servers under test.

Configuring the Windows time service on DC1

To ensure reliable time, we pointed our Active Directory server to a physical NTP server.

1. Open a command prompt.
2. Type the following:

```
W32tm /config /syncfromflags:manual /manualpeerlist:"<ip address of a NTP server>"
W32tm /config /reliable:yes
W32tm /config /update
W32tm /resync
Net stop w32time
Net start w32time
```

Setting up DHCP services on DC1

1. Click Start→Administrative Tools→Server Manager→Add Roles.
2. Select DHCP Server, and click Next.
3. At the Introduction to DHCP Server screen, click Next.
4. At the Specify IPv4 DNS Settings screen, type `domain.local` for the parent domain.
5. Enter the preferred DNS server IPv4 address, and click Next.
6. At the Specify IPv4 WINS Server Settings screen, select WINS is not required for applications on the network, and click Next.
7. At the Add or Edit DHCP Scopes screen, click Add.
8. At the Add Scope screen, enter the Name DHCP Scope name.

9. In the next box, set the following values, and click OK.
 - Start IP address=172.16.2.1
 - End IP address=172.16.100.200
 - Subnet mask=255.255.0.0
10. Check Activate This Scope.
11. At the Add or Edit DHCP Scopes screen, click Next.
12. Click Enable DHCP v6 Stateless Mode, and click Next.
13. Leave the default IPv6 DNS Settings, and click Next.
14. At the Authorize DHCP server dialog box, select Use current credentials.
15. At the Confirm Installation Selections screen, click Next. If the installation is set up correctly, a screen displays saying the DHCP server install succeeded.
16. Click Close.

Setting up a VM to host the vCenter server (vCenter)

1. Log into the infra1 server with the VMware vSphere client.
2. In the VMware vSphere client, under Basic Tasks, select Create a new virtual machine.
3. Choose Custom, and click Next.
4. Assign the name vCenter to the virtual machine, and click Next.
5. Select infra1 as the host, and click Next.
6. Select the appropriate storage, and click Next.
7. Choose Virtual Machine Version 8, and click Next.
8. Choose Windows, choose Microsoft Windows Server 2008 R2 (64-bit), and click Next.
9. For CPUs, select one virtual processor socket, and four cores per virtual socket, and click Next.
10. Choose 8GB RAM, and click Next.
11. Click 1 for the number of NICs, select VMXNET3, connect to the PRIV-NET port group, and click Next.
12. Leave the default virtual storage controller, and click Next.
13. Keep the default virtual device node (0:0), and click Next.
14. Connect the VM virtual CD-ROM to the Microsoft Windows 2008 R2 installation disk.
15. Click Finish.
16. Right-click the vCenter VM, and click Edit settings.
17. Click the Resources tab, click Memory, check the Reserve all guest memory checkbox, and click OK.
18. Start the VM.

Installing the Microsoft Windows Server 2008 R2 operating system on the VM

1. Open a virtual machine console on vCenter.
2. Choose the language, time and currency, and keyboard input. Click Next.
3. Click Install Now.
4. Choose Windows Server 2008 R2 Enterprise (Full Installation), and click Next.
5. Accept the license terms, and click Next.
6. Click Custom.

7. Click the Disk, and click Drive options (advanced).
8. Click New→Apply→Format, and click Next.
9. After the installation completes, click OK to set the Administrator password.
10. Enter the administrator password twice, and click OK.
11. Install VMware Tools. For more information, see kb.vmware.com/selfservice/microsites/search.do?language=en_US&cmd=displayKC&externalId=340.
12. Reboot.
13. Connect the machine to the Internet, and install all available Windows updates. Restart as necessary.
14. Enable remote desktop access.
15. Change the hostname to `vCenter`, and reboot when the installation prompts you.
16. Set up networking for the data network:
 - a. Click Start, Control Panel, right-click Network Connections, and choose Open.
 - b. Right-click the VM traffic NIC, and choose Properties.
 - c. Uncheck TCP/IP (v6).
 - d. Select TCP/IP (v4), and choose Properties.
 - e. Set the IP address, subnet, gateway, and DNS server.
17. Join the domain.local domain.
18. Reboot the system.

Setting up a VM to host Microsoft SQL server (SQL) for infrastructure

1. Connect to the infra1 server via the VMware vSphere client.
2. Log in as `root`
3. In the VMware vSphere client, under Basic Tasks, select Create a new virtual machine.
4. Choose Custom, and click Next.
5. Assign the name `SQL` to the virtual machine, and click Next.
6. Select infra1 as the host, and click Next.
7. Select the appropriate storage, and click Next.
8. Choose Virtual Machine Version 9, and click Next.
9. Choose Windows, choose Microsoft Windows Server 2008 R2 (64-bit), and click Next.
10. For CPUs, select one virtual processor socket, and two cores per virtual socket, and click Next.
11. Choose 4 GB RAM, and click Next.
12. Click 1 for the number of NICs, select VMXNET3, connect to the PRIV-NET network, and click Next.
13. Leave the default virtual storage controller, and click Next.
14. Choose to create a new virtual disk, and click Next.
15. Make the OS virtual disk size 100 GB, choose thin-provisioned lazy zeroed, specify external storage, and click Next.
16. Keep the default virtual device node (0:0), and click Next.
17. Click Finish.
18. Right-click the VM, and choose Edit Settings.

19. Click the Resources tab, and click Memory.
20. Select Reserve all guest memory, and click OK.
21. Connect the VM virtual CD-ROM to the Microsoft Windows Server 2008 R2 installation disk.
22. Start the VM.

Installing the Microsoft Windows Server 2008 R2 operating system on the VM

1. Open a virtual machine console on SQL.
2. Choose the language, time and currency, and keyboard input. Click Next.
3. Click Install Now.
4. Choose Windows Server 2008 R2 Enterprise (Full Installation), and click Next.
5. Accept the license terms, and click Next.
6. Click Custom.
7. Click the Disk, and click Drive options (advanced).
8. Click New→Apply→Format, and click Next.
9. After the installation completes, click OK to set the Administrator password.
10. Enter the administrator password twice, and click OK.
11. Install VMware Tools. For more information, see kb.vmware.com/selfservice/microsites/search.do?language=en_US&cmd=displayKC&externalId=340.
12. Reboot the server.
13. Connect the machine to the Internet, and install all available Windows updates. Restart as necessary.
14. Enable remote desktop access.
15. Change the hostname to SQL, and reboot when the installation prompts you.
16. Set up networking for the data network:
 - a. Click Start→Control Panel, right-click Network Connections, and choose Open.
 - b. Right-click the VM traffic NIC, and choose Properties.
 - c. Uncheck TCP/IP (v6).
 - d. Select TCP/IP (v4), and choose Properties.
 - e. Set the IP address, subnet, gateway, and DNS server.

Installing Microsoft SQL Server 2008 R2

1. Insert the installation media, and click OK to install .NET framework.
2. Wait for the SQL Installer to launch. On the left menu, click Installation.
3. Click New installation or add features to an existing installation. Click OK.
4. Enter the Product Key, and click Next.
5. Check the I accept the license terms checkbox, and click Next.
6. Click Install to install the Setup Support Files (required).
7. Resolve any issues displayed in the setup wizard, and click Next.
8. At the Setup Role screen, select SQL Server Feature Installation, and click Next.
9. Select Database Engine Services, Full-Text Search, Client tools Backwards Compatibility, Management Tools Basic and Complete, and click Next twice.

10. Accept instance configuration defaults, and click Next.
11. Accept defaults for disk space requirements, and click Next.
12. Click Use the same account for all SQL Server services, select NT Authority\System, and click OK. Click Next.
13. Select Mixed Mode, and enter a password for the SA account. Click Add Current User, and click Next.
14. Accept defaults for error reporting, and click Next.
15. Review installation configuration rules check, and click Next.
16. To begin the installation, click Install.
17. At the completion screen, click Close.
18. Run Windows Update to receive all updates and security patches.

Setting up databases for vCenter and VMware View™ Composer

1. Log on to SQL as `DOMAIN\administrator`
2. From the server desktop, open Start→All Programs→Microsoft SQL Server 2008 R2→Configuration Tools→SQL Server Configuration Manager.
3. Click SQL Server Network Configuration→Protocols for MSSQLSERVER.
4. Right-click TCP/IP, and select Enabled.
5. Click SQL Services→right-click SQL Server Browser, and select Properties.
6. In the SQL Server Browser Properties, select the Services tab, change the Start mode to Automatic, and click OK. Repeat this step for the SQL Server Agent service.
7. Start the SQL Server browser service and the SQL Server Agent service.
8. From the SQL server desktop, open Start→All Programs→Microsoft SQL Server 2008 R2→Configuration Tools→SQL Server Management Studio.
9. Click Connect.
10. Select the Databases folder, right-click, and select New Database.
11. Provide the name `vCenter` for the new database.
12. Select the Databases folder, right-click, and select New Database.
13. Provide the name `composer` for the new database.
14. Click Options, change the recovery model from full to simple, and click OK.

Setting up an ODBC DSN on vCenter

1. Log into vCenter as `DOMAIN\administrator`
2. Click Options and change the recovery model from full to simple, and click OK.
3. From the desktop of the vCenter server, select Start, Run, and type `odbcad32.exe`. Press Enter.
4. Click the system DSN tab.
5. Click Add.
6. Click SQL Server Native Client 10.0, and click Finish.
7. In the Create a New Data Source to SQL Server text box, type the connection name `vcenter`
8. For Server, select SQL, and click Next.
9. Change authentication to With SQL Server authentication using a login ID and password entered by the user, type `sa` as the Login ID, use the password you defined in SQL server setup for the SA account, and click Next.

10. Select Change the default database to choose vCenter from the pull-down menu, and click Next.
11. Click Finish.
12. Click Test Data Source... to confirm correct configuration.
13. Click OK to create the vCenter ODBC connection.

Installing VMware vCenter 5.5

1. Log into vCenter as `DOMAIN\administrator`
2. From the VMware vCenter 5.5 install media, click Autorun.
3. Click Run to start the install wizard.
4. Click the Install button on the VMware vSphere 5.5 Simple Install wizard.
5. Select the Install wizard language as English, and click OK.
6. At the Install wizard welcome screen, click Next.
7. At the End User Patent Agreement, click Next.
8. Agree to the License Agreement, and click Next.
9. Enter and confirm the password you wish to use with the Administrator account for vCenter Single Sign On, and click Next.
10. Select Install a local Microsoft SQL Server 2008 R2 Express Instance, and click Next.
11. Enter and confirm the passwords for the DBA and SQL user accounts, and click Next.
12. Confirm the Fully Qualified Domain Name or IP address is correct, and click Next.
13. Check the Use network service account checkbox, and click Next.
14. Accept the default installation path, and click Next.
15. Accept the default https port, and click Next.
16. Click Install.
17. After Single Sign On completes, and vCenter Server installation begins, enter user information and a license key, and click Next.
18. Select Use an existing supported database, and select the Data Source Name (DSN) for the connection to the SQL Server: `vcenter`
19. Type `sa` as the database username, provide the password for the SA account, and click Next.
20. Select the system account for the vCenter Server service account, and click Next.
21. Keep the vCenter default ports, and click Next.
22. Select 1024 MB for the JVM memory, and click Next.
23. Click Install to finish the vCenter server installation.
24. Click Finish to exit the wizard.
25. Click OK to confirm completion.
26. Click Exit on the installer.
27. Restart the server.
28. Using the vSphere client, log into the vCenter server as `DOMAIN\administrator`
29. Right-click the root of vCenter, and click New Data center.
30. Name the new data center `datacenter`

31. Add the servers under test and infrastructure servers to the data center.
32. Upgrade DC1, vCenter, and SQL to VMware hardware version.

Setting up a VM to host VMWare View Composer

1. Log into the vCenter via the VMware Web client.
2. Click the Virtual Machines tab.
3. Right-click, and choose New Virtual Machine.
4. Select Create a new virtual machine.
5. Choose Custom, and click Next.
6. Assign the name `composer` to the virtual machine, and click Next.
7. Select `infra1` as the host, and click Next.
8. Select the appropriate storage, and click Next.
9. Choose Virtual Machine Version 9, and click Next.
10. Choose Windows, choose Microsoft Windows Server 2008 R2 (64-bit), and click Next.
11. For CPUs, select one virtual processor socket, and four cores per virtual socket, and click Next.
12. Choose 8GB RAM, and click Next.
13. Click 1 for the number of NICs, select VMXNET3, connect to the PRIV-NET port group, and click Next.
14. Leave the default virtual storage controller, and click Next.
15. Keep the default virtual device node (0:0), and click Next.
16. Connect the VM virtual CD-ROM to the Microsoft Windows 2008 R2 installation disk.
17. Click Finish.
18. Right-click the `composer` VM, and click Edit settings.
19. Click the Resources tab, click Memory, check the Reserve all guest memory checkbox, and click OK.
20. Start the VM.

Installing the Microsoft Windows Server 2008 R2 operating system on the VM

1. Open a virtual machine console on the `composer` VM.
2. Choose the language, time and currency, and keyboard input. Click Next.
3. Click Install Now.
4. Choose Windows Server 2008 R2 Enterprise (Full Installation), and click Next.
5. Accept the license terms, and click Next.
6. Click Custom.
7. Click the Disk, and click Drive options (advanced).
8. Click New→Apply→Format, and click Next.
9. After the installation completes, click OK to set the Administrator password.
10. Enter the administrator password twice, and click OK.
11. Install VMware Tools. For more information, see kb.vmware.com/selfservice/microsites/search.do?language=en_US&cmd=displayKC&externalId=340.
12. Reboot.
13. Connect the machine to the Internet, and install all available Windows updates. Restart as necessary.

14. Enable remote desktop access.
15. Change the hostname to `composer`, and reboot when the installation prompts you.
16. Set up networking for the data network:
 - a. Click Start, Control Panel, right-click Network Connections, and choose Open.
 - b. Right-click the VM traffic NIC, and choose Properties.
 - c. Uncheck TCP/IP (v6).
 - d. Select TCP/IP (v4), and choose Properties.
 - e. Set the IP address, subnet, gateway, and DNS server.
17. Join the domain.local domain.
18. Reboot the system.

Setting up a database and ODBC DSN for VMware View Composer

1. Log on to the composer VM as `DOMAIN\administrator`
2. From the desktop of the vCenter server, select Start, Run, and type `odbcad32.exe`. Press Enter.
3. Click the system DSN tab.
4. Click Add.
5. Click SQL Server Native Client 10.0, and click Finish.
6. In the Create a New Data Source to SQL Server text box, type the connection name `composer`
7. For Server, select SQL, and click Next.
8. Change authentication to With SQL Server authentication using a login ID and password entered by the user, type `sa` as the Login ID, use the password you defined in SQL server setup for the SA account, and click Next.
9. Select Change the default database to:, choose `composer` from the pull-down menu, and click Next.
10. Click Finish.
11. Click Test Data Source... to confirm correct configuration.
12. Click OK to create the Composer ODBC connection.

Setting up VMware Horizon View Composer 6

1. Open the View 5 media folder, and run the file named `VMware-viewcomposer-6.0.1`
2. At the Welcome screen and the Patents screen, click Next.
3. Accept the VMware end user license agreement, and click Next.
4. Leave the Destination folder as default, and click Next.
5. In the Database information box, type `composer` as the source name and `sa` as the user name. Enter the password, and click Next.
6. Leave the default SOAP port, and click Next.
7. Click Install, and click Finish.
8. Restart the server.

Setting up a VM to host the VMware View connection server

1. Log into the vCenter via the VMWare Web client.
2. Click the Virtual Machines tab.
3. Right-click, and choose New Virtual Machine.

4. Select Create a new virtual machine.
5. Choose Custom, and click Next.
6. Assign the name `View` to the virtual machine, and click Next.
7. Select infrastructure for the host, and click Next.
8. Select the appropriate storage, and click Next.
9. Choose Virtual Machine Version 9, and click Next.
10. Choose Windows, choose Microsoft Windows Server 2008 R2 (64-bit), and click Next.
11. For CPUs, select one virtual processor socket, and two cores per virtual socket, and click Next.
12. Choose 4GB RAM, and click Next.
13. Click 1 for the number of NICs, select VMXNET 3, connect to the PRIV-NET port group, and click Next.
14. Leave the default virtual storage controller, and click Next.
15. Choose to create a new virtual disk, and click Next.
16. Make the OS virtual disk size 100 GB, choose thick-provisioned lazy zeroed, specify the OS datastore on the external storage, and click Next.
17. Keep the default virtual device node (0:0), and click Next.
18. Connect the VM virtual CD-ROM to the Microsoft Windows Server 2008 R2 installation disk.
19. Right-click the View Connection VM, and click Edit settings.
20. Click the Resources tab, click Memory, check the Reserve all guest memory checkbox, and click OK.
21. Click Finish.
22. Start the VM.

Installing the Microsoft Windows Server 2008 R2 operating system on the VM

1. Open a virtual machine console on the View VM.
2. Choose the language, time and currency, and keyboard input. Click Next.
3. Click Install Now.
4. Choose Windows Server 2008 R2 Enterprise (Full Installation), and click Next.
5. Accept the license terms, and click Next.
6. Click Custom.
7. Click the Disk, and click Drive options (advanced).
8. Click New→Apply→Format, and click Next.
9. After the installation completes, click OK to set the Administrator password.
10. Enter the administrator password twice, and click OK.
11. Install VMware Tools. For more information, see kb.vmware.com/selfservice/microsites/search.do?language=en_US&cmd=displayKC&externalId=340.
12. Reboot.
13. Connect the machine to the Internet, and install all available Windows updates. Restart as necessary.
14. Enable remote desktop access.
15. Change the hostname to `View`, and reboot when the installation prompts you.
16. Set up networking for the data network:

- a. Click Start, Control Panel, right-click Network Connections, and choose Open.
 - b. Right-click the VM traffic NIC, and choose Properties.
 - c. Uncheck TCP/IP (v6).
 - d. Select TCP/IP (v4), and choose Properties.
 - e. Set the IP address, subnet, gateway, and DNS server.
17. Join the VDI domain.
 18. Reboot the system.

Installing the VMware View Connection Server 6

1. Log into the server named View Connection.
2. Browse to VMware View installation media, and click VMware-viewconnectionsserver-x86_64-6.0.1
3. Click Run.
4. At the Welcome screen, click Next.
5. Agree to the End User License Agreement, and click Next.
6. Keep the default installation directory, and click Next.
7. Select View Standard Server, and click Next.
8. At the Data Recovery screen, enter a backup password, and click Next.
9. Allow View Server to configure the Windows firewall automatically, and click Next.
10. Authorize the local administrator to administer View, and click Next.
11. Choose whether to participate in the customer experience improvement program, and click Next.
12. Complete the installation wizard to finish installing View Connection Server.
13. Click Finish.
14. Reboot server.

Configuring the VMware Horizon View Connection Server

1. Open a Web browser to `<view connection server FQDN>/admin`
2. Log in as administrator
3. Under Licensing, click Edit License...
4. Enter a valid license serial number, and click OK.
5. Open View Configuration→Servers.
6. In the vCenter Servers tab, click Add...
7. Enter vCenter server credentials, and click Next.
8. At the View composer screen, select View Composer co-installed with vCenter Server, and click Next.
9. At the View composer domains screen, click Add...
10. Enter full domain name and user credentials.
11. At the storage screen select Reclaim VM disk space, and Enable View Storage Accelerator.
12. Change the Default host cache size to 1024 MB, and click Next.
13. At the ready to complete screen, click Finish.

Configuring VMware Virtual SAN

1. Log into the vCenter via the VMWare Web client.
2. Right click the datacenter and select New Cluster.

3. Name the cluster DELL VSAN and turn on the Virtual SAN feature.
4. Click OK.
5. Move all four FC430 server into the cluster.
6. Select the new cluster and under Manage, select Virtual SAN.
7. Under General, select Edit.
8. Select turn on Virtual SAN, and chose to automatically add disks to storage.
9. Click OK.

Setting up a Windows 7 Enterprise (x86) ESXi base image VM

1. Log into the vCenter via the VMWare Web client.
2. Click the Virtual Machines tab.
3. Right-click, and choose New Virtual Machine.
4. Select Create a new virtual machine.
5. Choose Custom, and click Next.
6. Assign the name `View-gold`, and click Next.
7. Select the c1-s8 host, and click Next.
8. Select the appropriate storage.
9. Choose Virtual Machine Version 9, and click Next.
10. Choose Windows, choose Microsoft Windows 7 (32-bit), and click Next.
11. For CPUs, select one virtual processor socket and two core per virtual socket, and click Next.
12. Choose 1.5 GB RAM, and click Next.
13. Click 1 for the number of NICs, select VMXNET 3, and click Next.
14. Leave the default virtual storage controller, and click Next.
15. Choose to create a new virtual disk, and click Next.
16. Make the OS virtual disk size 24 GB, choose Thin Provision, specify the OS datastore on the external storage, and click Next.
17. Keep the default virtual device node (0:0), and click Next.
18. Click Finish.
19. Click the Resources tab, click Memory, and check the Reserve all guest memory checkbox.
20. Click the Hardware tab, CD/DVD Drive, and Connect the VM virtual CD-ROM to the Microsoft Windows 7 x86 installation disk.
21. Click OK.

Installing Windows 7 Enterprise (x86) on ESXi base image VM

1. When the installation prompts you, press any key to begin setup.
2. Enter your language preferences, and click Next.
3. Click Install.
4. Accept the license terms, and click Next.
5. Select Custom, and select the drive that will contain the OS.
6. Click Install.
7. Type `user` for the username, and click Next.

8. Enter no password, and click Next.
9. At the system protection screen, select Use recommended settings, and click Next.
10. Enter your time zone, and click Next.
11. Select the Work Network setting, and click Next.
12. Install VMware Tools, and select Complete Installation. For more information, see kb.vmware.com/selfservice/microsites/search.do?language=en_US&cmd=displayKC&externalId=340.
13. Reboot.
14. Connect the machine to the Internet, and install all available Windows updates. Restart as necessary.
15. Join the domain and restart the VM
16. Install Microsoft Office Professional Plus 2010

Installing the VMware Horizon View 6 agent

1. Browse to the VMware Horizon View 6 media, and run the VMware-viewagent file.
2. Click Run.
3. At the Welcome screen, click Next.
4. Accept the VMware end user license agreement, and click Next.
5. Select defaults, and click Next.
6. Click Install.

Configuring Regedit for QuickPrep

1. Click Start→Run, and type `regedit`
2. Browse to HKEY_LOCAL_MACHINE\SYSTEM\CurrentControlSet\Services\vmware-viewcomposer-ga.
3. Right-click SkipLicenseActivation, and click Modify...
4. Change the value from 0 to 1.
5. Shut down the machine, and take a snapshot of the final disk image.

Deploying Virtual Desktops using VMware Horizon View.

1. Open the View Administrator.
2. Log in as `administrator`
3. Under Inventory click Pools, and then click Add...
4. Select Automatic Pool, and click Next.
5. Select Dedicated, and click Next.
6. Select View Composer linked clones, and click Next.
7. Type `pool` for the pool ID and display name, and click Next.
8. Leave the pool settings as defaults, and click Next.
9. Under Naming Pattern, enter an appropriate name pattern for the pool.
10. Under Pool Sizing, type `400` for Max number of desktops and the number of spare (power on) desktops.
11. Select provision all desktops up-front, and click Next.
12. Select the defaults under View Composer Disks, and click Next.
13. Under Storage Optimization, Select Use VMware Virtual SAN for the virtual machines deployed to the Dell cluster or, Do not use VMware Virtual SAN for the virtual machines deployed to the Cisco blades.
14. Under vCenter Settings, select the following depending on where you are deploying virtual machines:

- Parent VM
 - Snapshot
 - VM folder location
 - Host or cluster
 - Resource pool
 - Datastores
15. Under Advanced Storage Options, select Use View Storage Accelerator (OS disk, 7 days).
 16. Under Guest customization, select the following:
 - Domain: `domain.local`
 - AD container: `OU=Computers,OU=LoginVSI`
 - Select Use Quick Prep, and click Next.
 17. Click Finish.
 18. Select Entitle users after this wizard finishes.
 19. Select the LoginVSI group and click OK.

Installing the Login VSI 4 benchmark

Setting up a VM to host the Login VSI share

1. Connect to an infrastructure server via the VMware web client.
2. In the VMware vSphere client, under Basic Tasks, select Create a new virtual machine.
3. Choose Custom, and click Next.
4. Assign the name `VSI_share` to the virtual machine, and click Next.
5. Select `infra1` as the host, and click Next.
6. Select the appropriate storage, and click Next.
7. Choose Virtual Machine Version 9, and click Next.
8. Choose Windows, choose Microsoft Windows Server 2008 R2 (64-bit), and click Next.
9. For CPUs, select one virtual processor socket, and two cores per virtual socket, and click Next.
10. Choose 4 GB RAM, and click Next.
11. Click 1 for the number of NICs, select VMXNET3, connect to the PRIV-NET network, and click Next.
12. Leave the default virtual storage controller, and click Next.
13. Choose to create a new virtual disk, and click Next.
14. Make the OS virtual disk size 100 GB, choose thin-provisioned lazy zeroed, specify external storage, and click Next.
15. Keep the default virtual device node (0:0), and click Next.
16. Click Finish.
17. Right-click the VM, and choose Edit Settings.
18. Click the Resources tab, and click Memory.
19. Select Reserve all guest memory, and click OK.
20. Connect the VM virtual CD-ROM to the Microsoft Windows Server 2008 R2 installation disk.
21. Start the VM.

Installing the Microsoft Windows Server 2008 R2 operating system on the VM

1. Open a virtual machine console on VSIShare.
2. Choose the language, time and currency, and keyboard input. Click Next.
3. Click Install Now.
4. Choose Windows Server 2008 R2 Enterprise (Full Installation), and click Next.
5. Accept the license terms, and click Next.
6. Click Custom.
7. Click the Disk, and click Drive options (advanced).
8. Click New→Apply→Format, and click Next.
9. After the installation completes, click OK to set the Administrator password.
10. Enter the administrator password twice, and click OK.
11. Install VMware Tools. For more information, see kb.vmware.com/selfservice/microsites/search.do?language=en_US&cmd=displayKC&externalId=340.
12. Reboot the server.
13. Connect the machine to the Internet, and install all available Windows updates. Restart as necessary.
14. Enable remote desktop access.
15. Change the hostname to VSIShare, and reboot when the installation prompts you.
16. Set up networking for the data network:
 - a. Click Start→Control Panel, right-click Network Connections, and choose Open.
 - b. Right-click the VM traffic NIC, and choose Properties.
 - c. Uncheck TCP/IP (v6).
 - d. Select TCP/IP (v4), and choose Properties.
 - e. Set the IP address, subnet, gateway, and DNS server.

Installing the Login VSI benchmark on VSI_share

1. Log into VSI_Share.
2. Create a folder named c:\share
3. Right-click the c:\share folder, and click Properties.
4. Click the Sharing tab, and click Share...
5. Add everyone, system, and administrators to the Read/Write group, and click Share.
6. Unpack the Login VSI install media.
7. Open Datacenter setup\setup.exe.
8. At the welcome screen, click Next.
9. Select the share named \\vsishare\share, and click Next.
10. Check the Start Login VSI Management Console checkbox to start the Management Console when the setup is completed, and click Finish.
11. At the management console enter the path to your login VSI license file and click save.

Configuring Login VSI: AD setup

1. Open the VSI management console and click "1. AD setup."
2. Enter the following:

Base OU	DC=domain,DC=local
Username	LoginVSI
Password1	*****
Domain	(auto detect checked)
Number of users	600
Formatting length	1
Launcher user	Launcher-v4
Launcher password	*****

Click save to .ps1
3. Copy the VSIADSetup.ps1 file to \\DC1\c\$
4. Login to DC1, and execute the VSIADSetup.ps1 in Windows PowerShell™.

Creating Windows 7 Enterprise x64 image VSI Launchers

Using the vSphere client, we created a Windows 7 Enterprise x64 VM with 2 vCPUs and 12 GB of memory.

Installing VMware View Client on the launcher

1. Accept the VMware license terms.
2. Select default options.
3. Accept or change the destination folder.
4. Click on Install.

Installing Virtual Audio Cable

By default, the virtual launchers cannot render audio, so we installed Virtual Audio Cable version 4.10 from software.muzychenko.net/eng/vac.htm.

1. Download and extract the media.
2. Click Setup.
3. Click Yes to begin the install.
4. Click I accept to accept the software license agreement.
5. Click Install.

Converting the launcher VM to a template

1. In vSphere Client, right-click the launcher VM, and select Template→Convert to Template.

Deploying the launchers VM from the launcher template

1. In vSphere Client, browse to Home→VMs and Templates.
2. Right-click the launcher template to deploy a virtual machine from the template.
3. Type launcher_1 as the new VM name, and click Next.
4. Click Datacenter, and click Next.
5. Click on the launcher server, and click Next.
6. Select the appropriate storage, and click Next.

7. Select customization using existing customization specifications, select the appropriate file, and click Next.
8. Click Finish to deploy the new VM.
9. Repeat steps 1 through 8 to deploy more launchers.

Configuring VSI Launchers for testing

After all 24 launchers are configured and in an idle state, configure the login VSI test harness to add them to available launcher capacity.

1. Log on to VSI_Share as DOMAIN\administrator
2. Open the Login VSI management console.
3. Click "2. Add Launchers"
4. At the Add launchers wizard, click Next.
5. Click batch entry and enter the following:

```
Name=launcher  
Start number=1  
Increment=1  
Count=24  
Maximum capacity=30  
Formatting length=2
```

6. Click Next.
7. Click Finish.

Running the Login VSI benchmark

Before we ran our test, we executed assign_user.ps1 on the VMWare view server and statically assigned login_VSI users to virtual desktops so persona data would not be created randomly in testing. Next, we ran a profile create job in Login VSI to fully initialize each user's profile. Finally, we used 24 launchers to run a knowledge-worker workload in benchmarking mode. For more information on how to run a Login VSI test, see

www.loginvsi.com/documentation/index.php?title=Main_Page.

ABOUT PRINCIPLED TECHNOLOGIES



Principled Technologies, Inc.
1007 Slater Road, Suite 300
Durham, NC, 27703
www.principledtechnologies.com

We provide industry-leading technology assessment and fact-based marketing services. We bring to every assignment extensive experience with and expertise in all aspects of technology testing and analysis, from researching new technologies, to developing new methodologies, to testing with existing and new tools.

When the assessment is complete, we know how to present the results to a broad range of target audiences. We provide our clients with the materials they need, from market-focused data to use in their own collateral to custom sales aids, such as test reports, performance assessments, and white papers. Every document reflects the results of our trusted independent analysis.

We provide customized services that focus on our clients' individual requirements. Whether the technology involves hardware, software, Web sites, or services, we offer the experience, expertise, and tools to help our clients assess how it will fare against its competition, its performance, its market readiness, and its quality and reliability.

Our founders, Mark L. Van Name and Bill Catchings, have worked together in technology assessment for over 20 years. As journalists, they published over a thousand articles on a wide array of technology subjects. They created and led the Ziff-Davis Benchmark Operation, which developed such industry-standard benchmarks as Ziff Davis Media's Winstone and WebBench. They founded and led eTesting Labs, and after the acquisition of that company by Lionbridge Technologies were the head and CTO of VeriTest.

Principled Technologies is a registered trademark of Principled Technologies, Inc.
All other product names are the trademarks of their respective owners.

Disclaimer of Warranties; Limitation of Liability:

PRINCIPLED TECHNOLOGIES, INC. HAS MADE REASONABLE EFFORTS TO ENSURE THE ACCURACY AND VALIDITY OF ITS TESTING, HOWEVER, PRINCIPLED TECHNOLOGIES, INC. SPECIFICALLY DISCLAIMS ANY WARRANTY, EXPRESSED OR IMPLIED, RELATING TO THE TEST RESULTS AND ANALYSIS, THEIR ACCURACY, COMPLETENESS OR QUALITY, INCLUDING ANY IMPLIED WARRANTY OF FITNESS FOR ANY PARTICULAR PURPOSE. ALL PERSONS OR ENTITIES RELYING ON THE RESULTS OF ANY TESTING DO SO AT THEIR OWN RISK, AND AGREE THAT PRINCIPLED TECHNOLOGIES, INC., ITS EMPLOYEES AND ITS SUBCONTRACTORS SHALL HAVE NO LIABILITY WHATSOEVER FROM ANY CLAIM OF LOSS OR DAMAGE ON ACCOUNT OF ANY ALLEGED ERROR OR DEFECT IN ANY TESTING PROCEDURE OR RESULT.

IN NO EVENT SHALL PRINCIPLED TECHNOLOGIES, INC. BE LIABLE FOR INDIRECT, SPECIAL, INCIDENTAL, OR CONSEQUENTIAL DAMAGES IN CONNECTION WITH ITS TESTING, EVEN IF ADVISED OF THE POSSIBILITY OF SUCH DAMAGES. IN NO EVENT SHALL PRINCIPLED TECHNOLOGIES, INC.'S LIABILITY, INCLUDING FOR DIRECT DAMAGES, EXCEED THE AMOUNTS PAID IN CONNECTION WITH PRINCIPLED TECHNOLOGIES, INC.'S TESTING. CUSTOMER'S SOLE AND EXCLUSIVE REMEDIES ARE AS SET FORTH HEREIN.
